



schiebetechnik
kirchner

Gruppe 1
Seite 6 - 15

Aluminiumrahmen für Drehtüren



Gruppe 2
Seite 16 - 33

Vertikale Schiebetechnik für Möbel

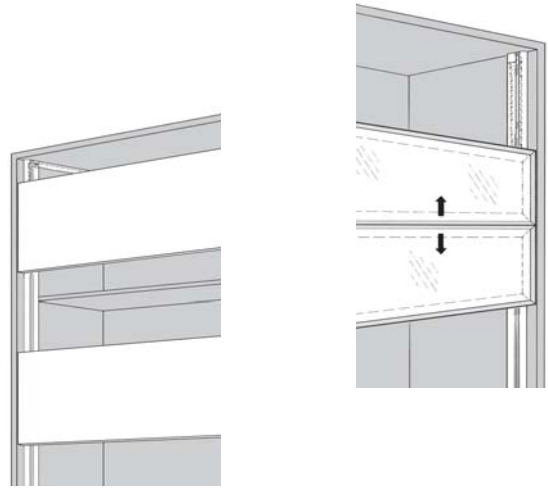

Gruppe 3
Seite 34 - 97

Schiebetechnik für Möbel-Glastüren



Gruppe 4
Seite 98 - 193

Schiebetechnik für Möbel-Holztüren

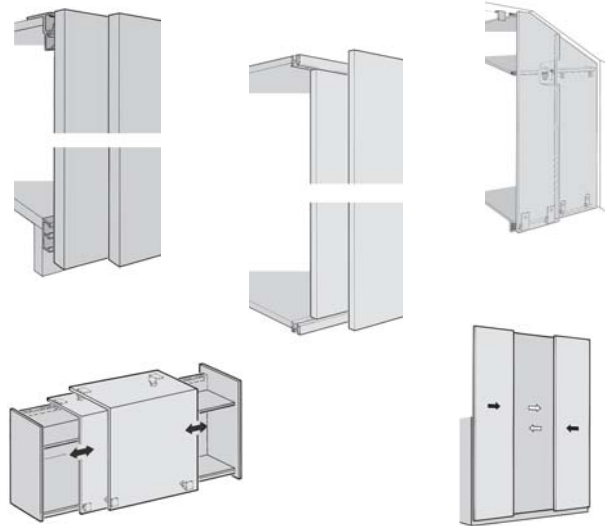

Gruppe 6
Seite 194 - 229

Schiebetechnik für Zimmertüren

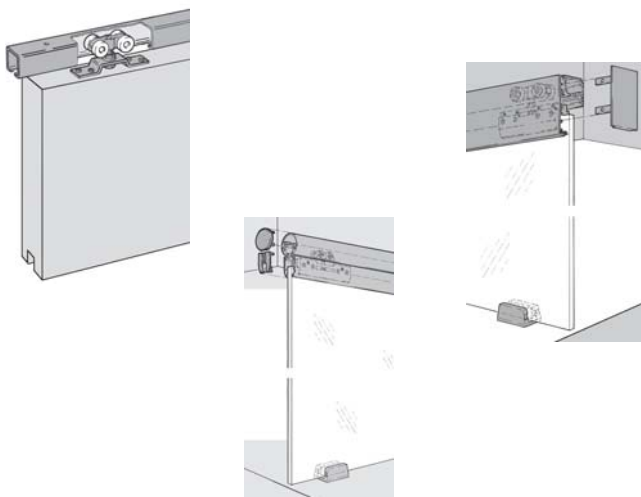

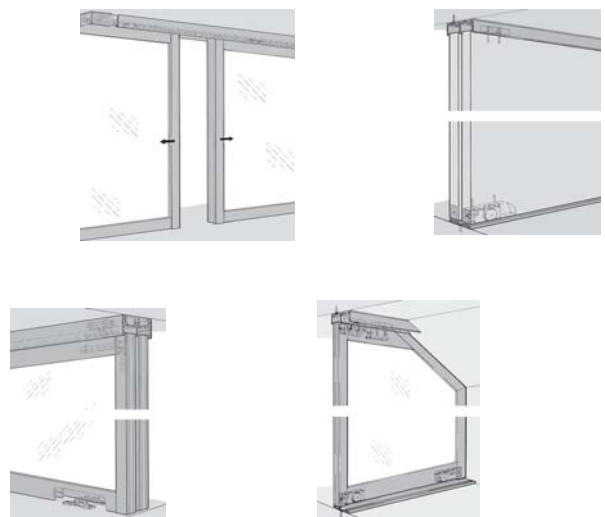

Gruppe 7
Seite 230 - 267

Schiebetechnik für Raumteiler



Inhaltsverzeichnis Glastüren / Alurahmen für Möbel

Alurahmen		Alu Rahmenprofile		Drehtür
		Glas	Profil B 19	6 - 7
			Profil B 45	8 - 9
			Profil B 50	10 - 11
			Quick-Frame	12 - 13
Holz	Frontrahmenprofil FR 21	14 - 15		

Glas Alurahmen		Türgewicht	Schiebetürbeschlag	Infront			Synchro	
		10 Kg	Clipo 15 GR 20/16	34 - 35	34 - 35			
			Clipo 15 GR 16/10	36 - 37				
			Regal C 15 GR 16/10	38 - 39				
		20 Kg	Libra GRS / GRG vertikal	24 - 25	26 - 27			28 - 31
		25 Kg	Clipo 25 GR 20/20	40 - 41			42 - 43	
			Regal C 25 GR 20/20	44 - 45			46 - 47	
			Regal A 25 GR 40/22				48 - 49	
			Frontal 25 GR 20/20				50 - 51	
		45 Kg	Frontal 25 GR 40/22				52 - 53	
			Frontino 45 GRS 60/26				54 - 55	
			Frontion 45 GRG 60/26				56 - 57	
			Tredue 45 GRS 60/26				58 - 59	
		60 Kg	Tredue 45 GRG 60/26				60 - 61	
			Combino 60 GR 60/35				64 - 65	62 - 63



Glas Aluprofil		Türgewicht	Schiebetürbeschlag	Infront			Synchro
		15 Kg	Clipo 15 GK	68 - 69			
			Clipo 15 GKK / GKS	70 - 71			
			Regal C 15 GKK	72 - 73			
		35 Kg	Clipo 35 GK	74 - 75			
			Clipo 35 GKK	76 - 77			
			Clipo 35 GKK Festglas	78 - 79			
			Clipo 35 G	80 - 81			
			Clipo 35 GF Festglas	82 - 83			

Glas punktuell		Türgewicht	Schiebetürbeschlag	Infront			Synchro	
		15 Kg	Clipo 15 GC	84 - 85				
			Clipo 15 GS	86 - 87				
			Regal C 15 GS				88 - 89	
		25 Kg	Regal B 25 G				90 - 91	
			Regal B 25 GA				92 - 93	
			Regal B 25 SP				94 - 95	
Frontal 25 G					96 - 97			

Zubehör		Schließsystem für Glasprofil	
		Clipo 35 GK und GKK	188-189

Inhaltsverzeichnis Holztüren für Möbel

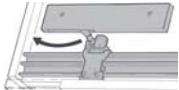
Holz		Türgewicht	Schiebetürbeschlag	Infront			Synchro
		10 Kg	Clipo 10 S	98 - 99			
15 Kg	Clipo 15 SH	100-101			102-103		
	Clipo 15 V	104-105			106-107		
	Clipo 15 H		108-109				
	Regal C 15 SH	110-111					
20 Kg	Frontino 20		112-113				
	Combino 20	114-117	120-121	118-119			
	Libra 20 H vertikal	16 - 17	18 - 19		20 - 23		
25 Kg	Clipo 25 S	122-123			124-125		
	Tredue 25 S				126-127		
	Regal A 25 H			128-129			
	Regal B 25 H			130-131			
	Regal C 25 V	132-133					
	Frontal 25 H			134-135			
	Creation 25 H	136-137	136-137				
	Creation 25 GH	138-139	138-139				
35 Kg	Combino 35	140-141	144-145	142-143	146-147		
	Clipo 35 S	148-149			150-151		
	Tredue 35 S				152-153		
	Clipo 35 V	154-155			156-157		
	Clipo 35 VB	158-159					
40 Kg	Regal A 40 H			160-161			
	Combino L 40			162-163			
45 Kg	Frontino 45 H			168-169	166-167		
	Tredue 45 H			170-171			
	Frontino 45 DS			172-173			
50 Kg	Combino U 50			164-165			
60 Kg	Combino 60 H	174-175	180-181	176-179	182-183		
	Combino 60 H U				178-179		
	Tredue 60 H			184-185			

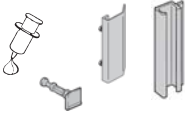
Zubehör		Dämpfungs-System für Holz- u. Alurahmentüren	186-187
		Ausrichtbeschlag für Holzschiebetüren	187
		Griffleisten und Griffe Klebstoffe, Befestigungen	190-191

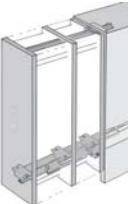
Hochschrankauszug		Hochschrankauszug FORTE	192-193
-------------------	---	-------------------------	---------

Inhaltsverzeichnis Zimmertüren (Porta) und Raumteiler (Divido)

Glas		Türgewicht	Beschlag	Wand- u. Deckenmontage	Synchro	
		40 Kg	Porta 40 GL	194-195		
			Porta 40 GLD	196-197		
		100 Kg	Porta 100 GW	198-199	202-203	
			Porta 100 GWF	200-201	202-203	
			Porta 100 G	204-205	214-215	
			Porta 100 GU	206-207		
			Porta 100 GM	208-209		
			Porta 100 GF	210-211	214-215	
Porta 100 GFO	212-213		214-215			

Glas Alurahmen		Türgewicht	Beschlag	Wand- u. Deckenmontage	Synchro	
		100 Kg	Divido 100 RSO	240-241	242-243	
			Divido 100 RMO	244-245		
				Türgewicht	Beschlag	Untenlaufend
80 Kg	Divido 80 RSU	254-261				

Holz		Türgewicht	Beschlag	Wand- u. Deckenmontage	Synchro	
		60 Kg	Porta 60 S	218-219	224-225	
			Porta 60 C	220-221		
			Porta 60 M	222-223		
		100 Kg	Porta 100 S	218-219	224-225	
			Porta 100 C	220-221		
			Porta 100 M	222-223		
			Divido 100 HSO	230-231	232-233	
			Divido 100 HMO	236-237		
		300 Kg	Porta 300 S	226-227		
			Porta 300 T	226-227		
		600 Kg	Porta 600 S	228-229		
			Porta 600 T	228-229		
		Türgewicht	Beschlag	Untenlaufend		
80 Kg	Divido 80 HSU	246-253				

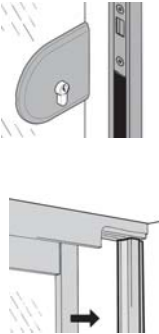
Zubehör			
		Glastürschloß Toplock	216-217
	Wandausgleichsprofil	262	